

# DrayTek

## Vigor2765 Series

35b Security Router



QUICK START GUIDE (RF MODEL)

V1.6

# Vigor2765

## 35b Series Router

### Quick Start Guide

#### (For RF Model)

Version: 1.6

Firmware Version: V4.4.2

(For future update, please visit [DrayTek web site](#))

Date: November 2, 2022

## Intellectual Property Rights (IPR) Information

### Copyrights

© All rights reserved. This publication contains information that is protected by copyright. No part may be reproduced, transmitted, transcribed, stored in a retrieval system, or translated into any language without written permission from the copyright holders.

### Trademarks

The following trademarks are used in this document:

- Microsoft is a registered trademark of Microsoft Corp.
- Windows 7, 8, 10, 11 and Explorer are trademarks of Microsoft Corp.
- Apple and Mac OS are registered trademarks of Apple Inc.
- Other products may be trademarks or registered trademarks of their respective manufacturers.

## Safety Instructions and Approval

### Safety Instructions

- Read the installation guide thoroughly before you set up the router.
- The router is a complicated electronic unit that may be repaired only by authorized and qualified personnel. Do not try to open or repair the router yourself.
- Do not place the router in a damp or humid place, e.g. a bathroom.
- Do not stack the routers.
- The router should be used in a sheltered area, within a temperature range of 0 to +45 Celsius.
- Do not expose the router to direct sunlight or other heat sources. The housing and electronic components may be damaged by direct sunlight or heat sources.
- Do not deploy the cable for LAN connection outdoor to prevent electronic shock hazards.
- Keep the package out of reach of children.
- When you want to dispose of the router, please follow local regulations on conservation of the environment.

### Warranty

We warrant to the original end user (purchaser) that the router will be free from any defects in workmanship or materials for a period of two (2) years from the date of purchase from the dealer. Please keep your purchase receipt in a safe place as it serves as proof of date of purchase. During the warranty period, and upon proof of purchase, should the product have indications of failure due to faulty workmanship and/or materials, we will, at our discretion, repair or replace the defective products or components, without charge for either parts or labor, to whatever extent we deem necessary to restore the product to proper operating condition. Any replacement will consist of a new or re-manufactured functionally equivalent product of equal value, and will be offered solely at our discretion. This warranty will not apply if the product is modified, misused, tampered with, damaged by an act of God, or subjected to abnormal working conditions. The warranty does not cover the bundled or licensed software of other vendors. Defects which do not significantly affect the usability of the product will not be covered by the warranty. We reserve the right to revise the manual and online documentation and to make changes from time to time in the contents hereof without obligation to notify any person of such revision or changes.



## Declaration of Conformity

Hereby, DrayTek Corporation declares that the radio equipment type Vigor2765 is in compliance with Directive 2014/53/EU.

The full text of the EU declaration of conformity is available at the following internet address:  
<https://fw.draytek.com.tw/Vigor2765/Document/CE/>

Manufacturer: DrayTek Corp.

Address: No.26, Fushing Rd., Hukou, Hsinchu Industrial Park, Hsinchu 303, Taiwan

Product: Vigor2765 Wireless Series

Frequency Information for Europe area:

2.4GHz WLAN	For ac model, 2400MHz - 2483MHz, max. TX power: 19.79dBm *1 For ax model, 2400MHz - 2483MHz, max. TX power: 19.81dBm *1
5GHz WLAN	For ac model, 5150MHz - 5350MHz, max. TX power: 22.74dBm *2 5470MHz - 5725MHz, max. TX power: 29.88dBm *2 For ax model, 5150MHz - 5350MHz, max. TX power: 22.70dBm *2 5470MHz - 5725MHz, max. TX power: 29.47dBm *2
	Requirements in AT/BE/BG/CZ/DZ/DK/EE/FR/DE/IS/IE/IT/EL/ES/ CY/LV/LI/LT/LU/HU/MT/NL/NO/PL/PT/RO/SI/SK/TR/FI/SE/CH/HR. 5150MHz-5350MHz is for indoor use only.

(\*1: for 2.4GHz WLAN model; \*2: for 5GHz WLAN model)

This product is designed for DSL and 2.4GHz /5GHz WLAN network throughout the EC region.



## Declaration of Conformity

Hereby, DrayTek Corporation declares that the radio equipment type Vigor2765 series router is in compliance with Regulation SI 2017 No. 1206.

Manufacturer: DrayTek Corp.

Address: No. 26, Fushing Rd., Hukou, Hsinchu Industrial Park, Hsinchu 303, Taiwan

Product: Vigor2765 Wireless Series

Importer: CMS Distribution Ltd: Bohola Road, Kiltimagh, Co Mayo, Ireland

Frequency Information for UK area:

2.4GHz WLAN	For ac model, 2400MHz - 2483MHz, max. TX power: 19.79dBm *1 For ax model, 2400MHz - 2483MHz, max. TX power: 19.81dBm *1
5GHz WLAN	For ac model, 5150MHz - 5350MHz, max. TX power: 22.74dBm *2 5470MHz - 5725MHz, max. TX power: 29.88dBm *2 For ax model, 5150MHz - 5350MHz, max. TX power: 22.70dBm *2 5470MHz - 5725MHz, max. TX power: 29.47dBm *2
	Requirements in UK. 5150MHz-5350MHz is for indoor use only.

(\*1: for 2.4GHz WLAN model; \*2: for 5GHz WLAN model)

This product is designed for DSL and 2.4GHz /5GHz WLAN network use in the UK & Ireland.



## Regulatory Information

### Federal Communication Commission Interference Statement

This equipment has been tested and found to comply with the limits for a Class B digital device, pursuant to Part 15 of the FCC Rules. These limits are designed to provide reasonable protection against harmful interference in a residential installation. This equipment generates, uses and can radiate radio frequency energy and, if not installed and used in accordance with the instructions, may cause harmful interference to radio communications. However, there is no guarantee that interference will not occur in a particular installation. If this equipment does cause harmful interference to radio or television reception, which can be determined by turning the equipment off and on, the user is encouraged to try to correct the interference by one of the following measures:

- Reorient or relocate the receiving antenna.
- Increase the separation between the equipment and receiver.
- Connect the equipment into an outlet on a circuit different from that to which the receiver is connected.
- Consult the dealer or an experienced radio/TV technician for help.

This device complies with Part 15 of the FCC Rules. Operation is subject to the following two conditions:

- (1) This device may not cause harmful interference, and
- (2) This device may accept any interference received, including interference that may cause undesired operation.

## RF Exposure Warning

This equipment must be installed and operated in accordance with provided instructions and the antenna(s) used for this transmitter must be installed to provide a separation distance of at least 20 cm from all persons and must not be co-located or operating in conjunction with any other antenna or transmitter. End-users and installers must be provided with antenna installation instructions and transmitter operating conditions for satisfying RF exposure compliance.

USA Local Representative	Company name	ABP International Inc.		
	Address	13988 Diplomat Drive Suite 180 Dallas TX 75234		
	ZIP Code	75234	E-mail	rmesser@abptech.com
	Contact Person	Mr. Robert Messer	Tel.	19728311600

## Caution

Any changes or modifications not expressly approved by the grantee of this device could void the user's authority to operate the equipment.

The antenna/transmitter should be kept at least 20 cm away from human body.



More update, please visit [www.draytek.com](http://www.draytek.com).

\*The external power supply used for each product will be model dependent.

	1	2	3	4	5	6	7	8	9
A Manufacturer	CWT	CWT	CWT	CWT	CWT	APD	APD	APD	APD
B Address	No. 222, Sec. 2, Nankan Rd., Lujhu Township, Taoyuan County 338, Taiwan	No. 222, Sec. 2, Nankan Rd., Lujhu Township, Taoyuan County 338, Taiwan	No. 222, Sec. 2, Nankan Rd., Lujhu Township, Taoyuan County 338, Taiwan	No. 222, Sec. 2, Nankan Rd., Lujhu Township, Taoyuan County 338, Taiwan	No. 222, Sec. 2, Nankan Rd., Lujhu Township, Taoyuan County 338, Taiwan	No.5, Lane 83, Lung-Sou St., Taoyuan City 330, Taiwan	No.5, Lane 83, Lung-Sou St., Taoyuan City 330, Taiwan	No.5, Lane 83, Lung-Sou St., Taoyuan City 330, Taiwan	No.5, Lane 83, Lung-Sou St., Taoyuan City 330, Taiwan
C Model identifier	2ABB012F UK	2ABB018F UK	2ABLO24F UK	2ABLO30F UK	2ABN036F UK	WA-12M12FG	WB-18D12FG	WA-24Q12FG	WA-36A12FG
	2ABB012F EU	2ABB018F EU	2ABLO24F EU	2ABLO30F EU	2ABN036F EU	WA-12M12FK	WB-18D12FK	WA-24Q12FK	WA-36A12FK
D Input voltage	100-240V	100-240V	100-240V	100-240V	100-240V	100-240V	100-240V	100-240V	100-240V
E Input AC frequency	50/60Hz	50/60Hz	50/60Hz	50/60Hz	50/60Hz	50/60Hz	50/60Hz	50/60Hz	50/60Hz
	Output voltage DC	12.0V	12.0V	12.0V	12.0V	12.0V	12.0V	12.0V	12.0V
F Output current	1.0A	1.5A	2.0A	2.5A	3.0A	1.0A	1.5A	2.0A	3.0A
G Output power	12.0W	18.0W	24.0W	30.0W	36.0W	12.0W	18.0W	24.0W	36.0W
H Average active efficiency	84.9%	86.2%	87.6%	87.8%	89.8%	83.7%	85.4%	88.6%	88.2%
I Efficiency at low load 10%	73.6%	78.0%	81.3%	83.3%	83.7%	74.5%	80.5%	86.4%	85.4%
J No-load power consumption	0.07W	0.07W	0.07W	0.07W	0.07W	0.07W	0.10W	0.07W	0.10W

External power supply (Power Adapter) information. For more update, please visit [www.draytek.com](http://www.draytek.com).

## ***Table of Contents***

<b>1. Package Content .....</b>	<b>1</b>
<b>2. Panel Explanation.....</b>	<b>2</b>
2.1 Vigor2765ac .....	2
2.2 Vigor2765Vac .....	4
2.3 Vigor2765ax .....	6
<b>3. Hardware Installation .....</b>	<b>8</b>
3.1 Network Connection for ac series .....	8
3.2 Network Connection for ax series .....	9
3.3 Wall-Mounted Installation for ac series .....	10
3.4 Wall-Mounted Installation for ax series .....	11
<b>4. Software Configuration .....</b>	<b>12</b>
<b>5. Customer Service .....</b>	<b>17</b>
Be a Registered Owner .....	17
Firmware & Tools Updates .....	17

# 1. Package Content

Take a look at the package content. If there is anything missed or damaged, please contact DrayTek or dealer immediately.



**Vigor router ac series & ax series**

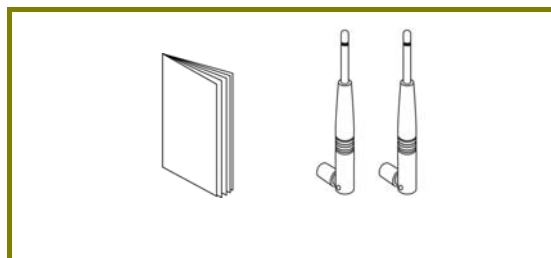

**Quick Start Guide, Antenna**



**RJ-45 Cable (Ethernet)**

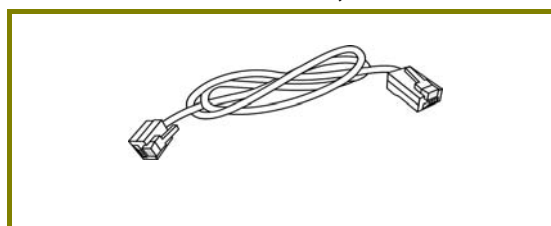

**RJ-11 to RJ-11 Cable (Annex A)**

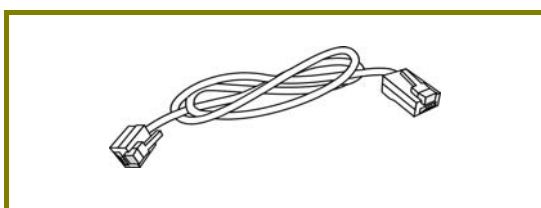

**RJ-11 to RJ-45 Cable (Annex B)**

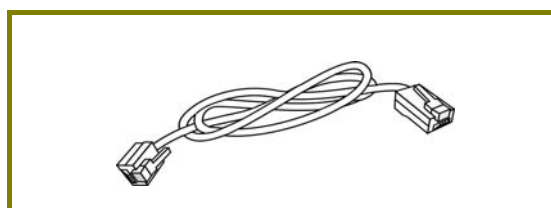

**RJ-45 to RJ-45 Cable (Annex B)**

The type of the power adapter depends on the country that the router will be installed. \* The maximum power consumption is *17-23 Watt*.

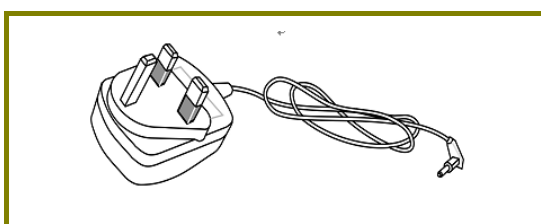

**UK-type Power Adapter**

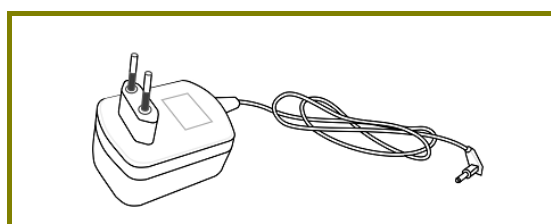

**EU-type Power Adapter**

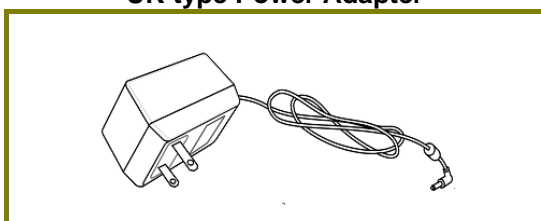

**USA/Taiwan-type Power Adapter**

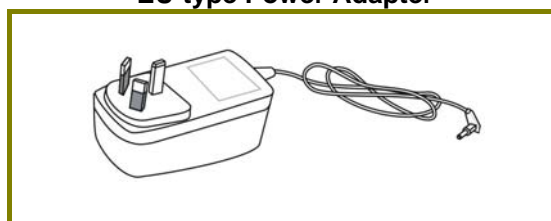

**AU/NZ-type Power Adapter**



**Note**







Remove the protective film from the router before use to ensure ventilation.

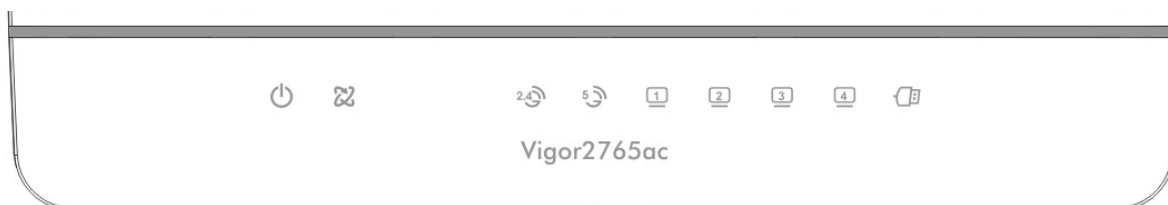

## 2. Panel Explanation

### 2.1 Vigor2765ac





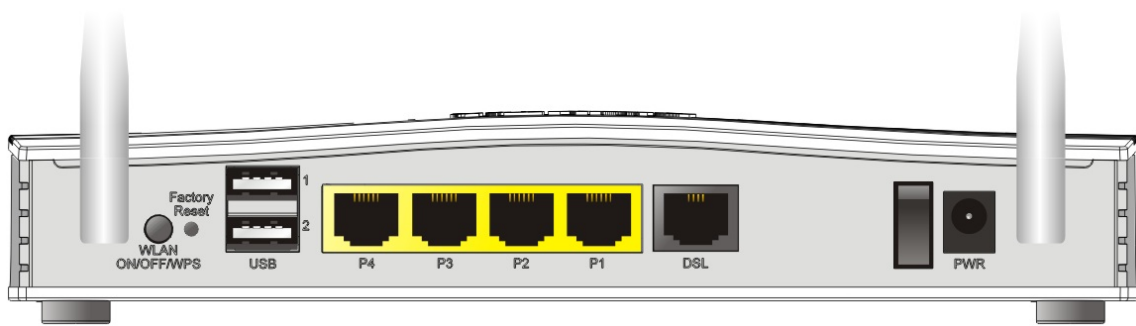





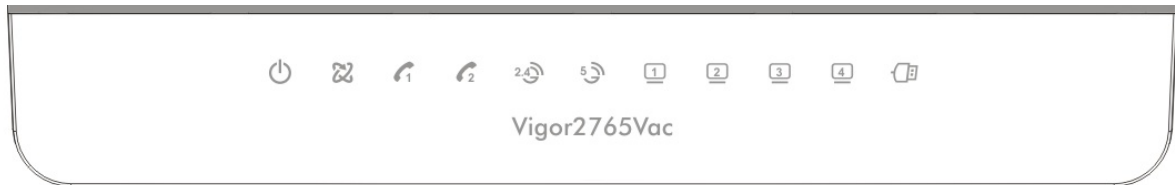

LED	Status	Explanation	
 (Activity)	Blinking	The router is powered on and running normally.	
	Off	The router is powered off.	
 (DSL)	Orange	On	The DSL link up, waiting for the Internet connection.
		Blinking	Slowly - The DSL connection is ready for training. Quickly - The DSL connection is synchronizing.
	Green	On	The router is ready to access to the Internet through DSL link.
		Blinking	The data is transmitting.
 (Wireless LAN On/Off/WPS)	On (Green)	The wireless access point is ready.	
	Blinking (Green)	The data is transmitting via wireless connection based on the rate of 2.4GHz.	
	Blinking (Orange)	Blinks with one second cycle for two minutes. The WPS function is active.	
	Off	The wireless access point is turned off.	
 (Wireless LAN On/Off/WPS)	On (Green)	The wireless access point is ready.	
	Blinking (Green)	The data is transmitting via wireless connection based on the rate of 5GHz.	
	Blinking (Orange)	Blinks with one second cycle for two minutes. The WPS function is active.	
 (LAN1/2/3/4)	On	The LAN port is connected.	
	Blinking	The data is transmitting.	
	Off	The LAN port is disconnected.	
 (USB)	On	A USB device is connected and active.	
	Blinking	The data is transmitting.	



Interface	Description
WLAN ON/OFF/WPS	<p>WLAN On - Press the button and release it within 2 seconds. When the wireless function is ready, the green LED will be on.</p> <p>WLAN Off - Press the button and release it within 2 seconds to turn off the WLAN function. When the wireless function is not ready, the LED will be off.</p> <p>WPS - When WPS function is enabled by web user interface, press this button for more than 2 seconds to wait for client's device making network connection through WPS.</p>
Factory Reset	<p>Restore the default settings.</p> <p>Usage: Turn on the router (ACT LED is blinking). Press the hole and keep for more than 5 seconds. When you see the ACT LED begins to blink rapidly than usual, release the button. Then the router will restart with the factory default configuration.</p>
USB1~USB2	Connector for a USB device (for 3G/4G USB Modem or printer).
P1~P4	Connectors for local networked devices.
DSL	Connector for accessing the Internet.
I/O	Power Switch.
PWR	Connector for a power adapter.

## 2.2 Vigor2765Vac





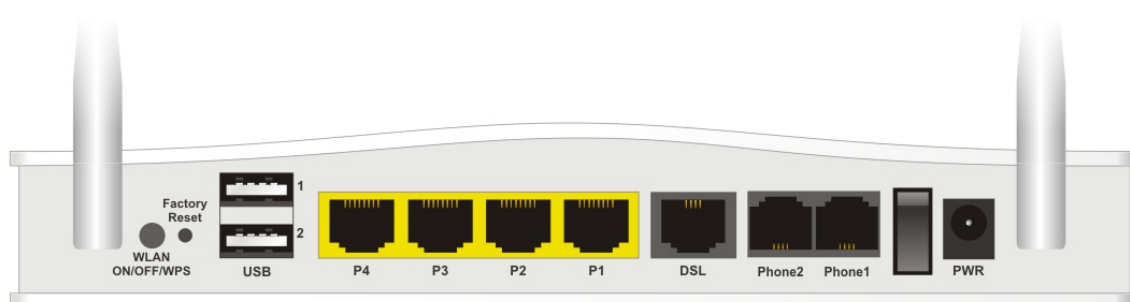

LED	Status	Explanation	
 (Activity)	Blinking	The router is powered on and running normally.	
	Off	The router is powered off.	
 (DSL)	Orange	On	The DSL link up, waiting for the Internet connection.
		Blinking	Slowly - The DSL connection is ready for training. Quickly - The DSL connection is synchronizing.
	Green	On	The router is ready to access to the Internet through DSL link.
		Blinking	The data is transmitting.
 	On	The phone connected to this port is off-hook.	
	Off	The phone connected to this port is on-hook.	
	Blinking	A phone call comes.	
 (Wireless LAN On/Off/WPS)	On (Green)	The wireless access point is ready.	
	Blinking (Green)	The data is transmitting via wireless connection based on the rate of 2.4GHz.	
	Blinking (Orange)	Blinks with one second cycle for two minutes. The WPS function is active.	
	Off	The wireless access point is turned off.	
 (Wireless LAN On/Off/WPS)	On (Green)	The wireless access point is ready.	
	Blinking (Green)	The data is transmitting via wireless connection based on the rate of 5GHz.	
	Blinking (Orange)	Blinks with one second cycle for two minutes. The WPS function is active.	
  ~ (LAN1/2/3/4)	On	The LAN port is connected.	
	Blinking	The data is transmitting.	
	Off	The LAN port is disconnected.	
 (USB)	On	A USB device is connected and active.	
	Blinking	The data is transmitting.	



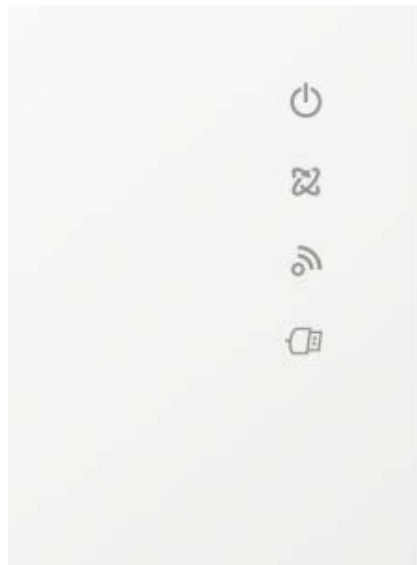



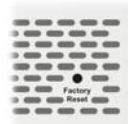
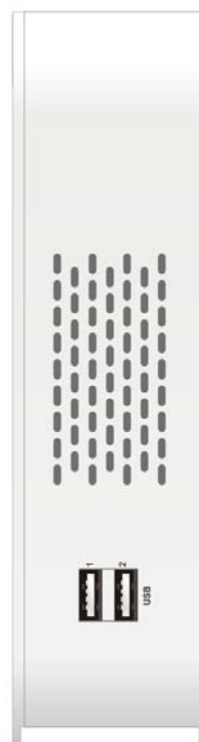
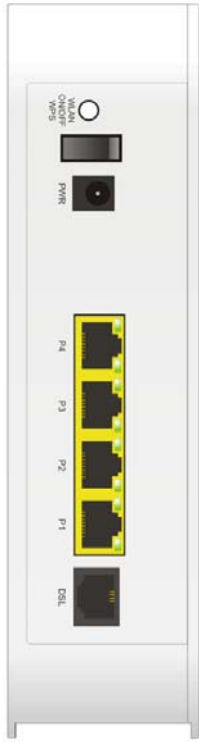

Interface	Description
WLAN ON/OFF/WPS	<p>WLAN On - Press the button and release it within 2 seconds. When the wireless function is ready, the green LED will be on.</p> <p>WLAN Off - Press the button and release it within 2 seconds to turn off the WLAN function. When the wireless function is not ready, the LED will be off.</p> <p>WPS - When WPS function is enabled by web user interface, press this button for more than 2 seconds to wait for client's device making network connection through WPS.</p>
Factory Reset	<p>Restore the default settings.</p> <p>Usage: Turn on the router (ACT LED is blinking). Press the hole and keep for more than 5 seconds. When you see the ACT LED begins to blink rapidly than usual, release the button. Then the router will restart with the factory default configuration.</p>
USB1~USB2	Connector for a USB device (for 3G/4G USB Modem or printer).
P1~P4	Connectors for local networked devices.
DSL	Connector for accessing the Internet.
Phone2/Phone1	Connector of analog phone for VoIP communication.
I/O	Power Switch.
PWR	Connector for a power adapter.

## 2.3 Vigor2765ax



LED	Status	Explanation	
 ACT	Off	The system is not ready or is failed.	
	Blinking	The system is ready and can work normally.	
	Blinking with WLAN	WPS is enabled and waiting for the response from the wireless client.	
 DSL	Orange	On	The DSL link up, waiting for the Internet connection.
		Blinking	Slowly - The DSL connection is ready for training. Quickly - The DSL connection is synchronizing.
	Green	On	The router is ready to access to the Internet through DSL link.
		Blinking	The data is transmitting.
 WLAN	Off	Wireless function is not ready.	
	On	Wireless function is ready.	
	Blinking	Data is transmitting (sending/receiving).	
	Blinking with WLAN	WPS is enabled and waiting for the response from the wireless client.	
 USB	On	A USB device is connected and active.	
	Blinking	The data is transmitting.	



Interface	Description
WLAN ON/OFF WPS	Wireless band will be switched /changed according to the button pressed and released. For example, <ul style="list-style-type: none"> <li>● 2.4G (On) and 5G (On) - in default.</li> <li>● 2.4G (Off) and 5G (On) - pressed and released the button once.</li> <li>● 2.4G (On) and 5G (Off) - pressed and released the button twice.</li> <li>● 2.4G (Off) and 5G (Off) - pressed and released the button three times.</li> </ul> WPS - When WPS function is enabled by web user interface, press this button for more than 2 seconds. The router will wait for any wireless client connecting to it through WPS.
	Power switch.
	PWR: Connector for a power adapter.
 LAN P4-P1	Connectors for local networked devices. <ul style="list-style-type: none"> <li>● Left LED on - The port is connected.</li> <li>● Left LED off - The port is disconnected.</li> <li>● Left LED Blinking - The data is transmitting.</li> <li>● Right LED on -The port is connected with 1000Mbps.</li> <li>● Right LED off - The port is connected with 10/100 Mbps.</li> </ul>
 DSL	Connector for accessing the Internet.
 USB	Connector for USB devices (for 3G/4G USB Modem or printer).
Factory Reset	Restore the default settings. Usage: Turn on the router. Press the button and keep for more than 10 seconds. Then the router will restart with the factory default configuration.

### 3. Hardware Installation

This section will guide you to install the router through hardware connection and configure the router's settings through web browser.

Before starting to configure the router, you have to connect your devices correctly.

#### 3.1 Network Connection for ac series

1. Connect the DSL interface to the land line jack with a DSL line cable.
2. Connect one port of 4-port switch to your computer with a RJ-45 cable. This device allows you to connect 4 PCs directly.
3. Connect detachable antennas to the router.
4. Connect one end of the power cord to the power port of this device. Connect the other end to the wall outlet of electricity.
5. Power on the router.
6. Check the ACT and DSL, LAN LEDs to assure network connection.

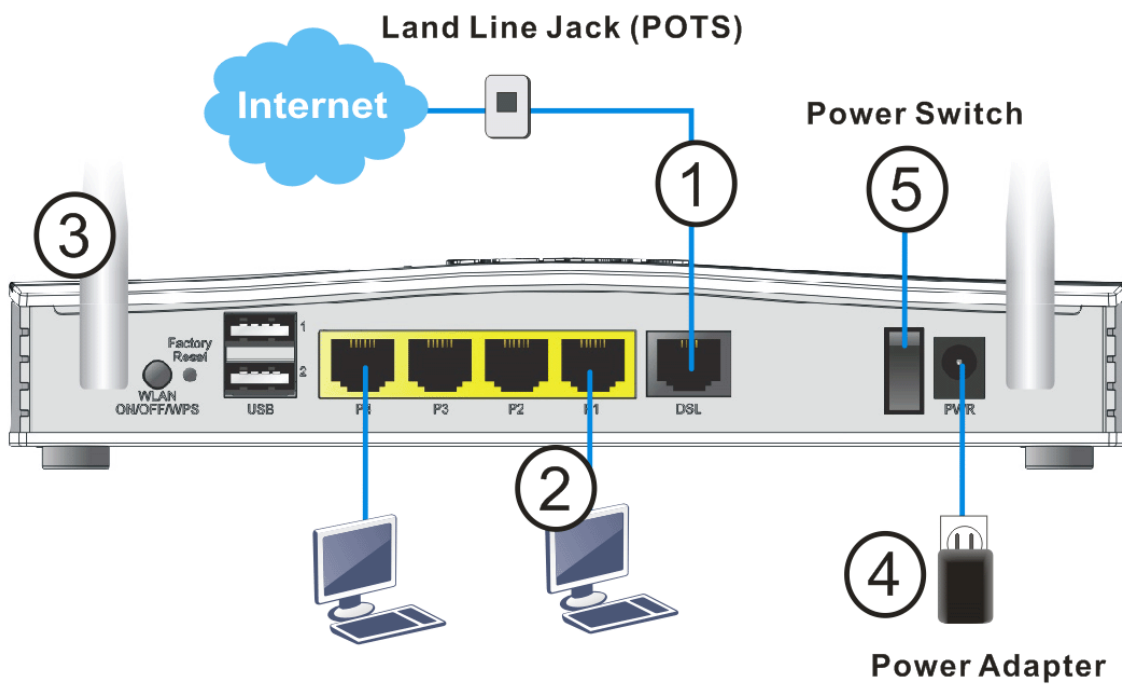

(For the detailed information of LED status, please refer to section 2.)

### 3.2 Network Connection for ax series

1. Connect the cable Modem/DSL Modem/Media Converter to any WAN port of router with Ethernet cable (RJ-45).
2. Connect one port of 4-port switch to your computer with a RJ-45 cable. This device allows you to connect 4 PCs directly.
3. Connect one end of the power cord to the power port of this device. Connect the other end to the wall outlet of electricity.
4. Power on the router.
5. Check the ACT and WAN LEDs to assure network connection.

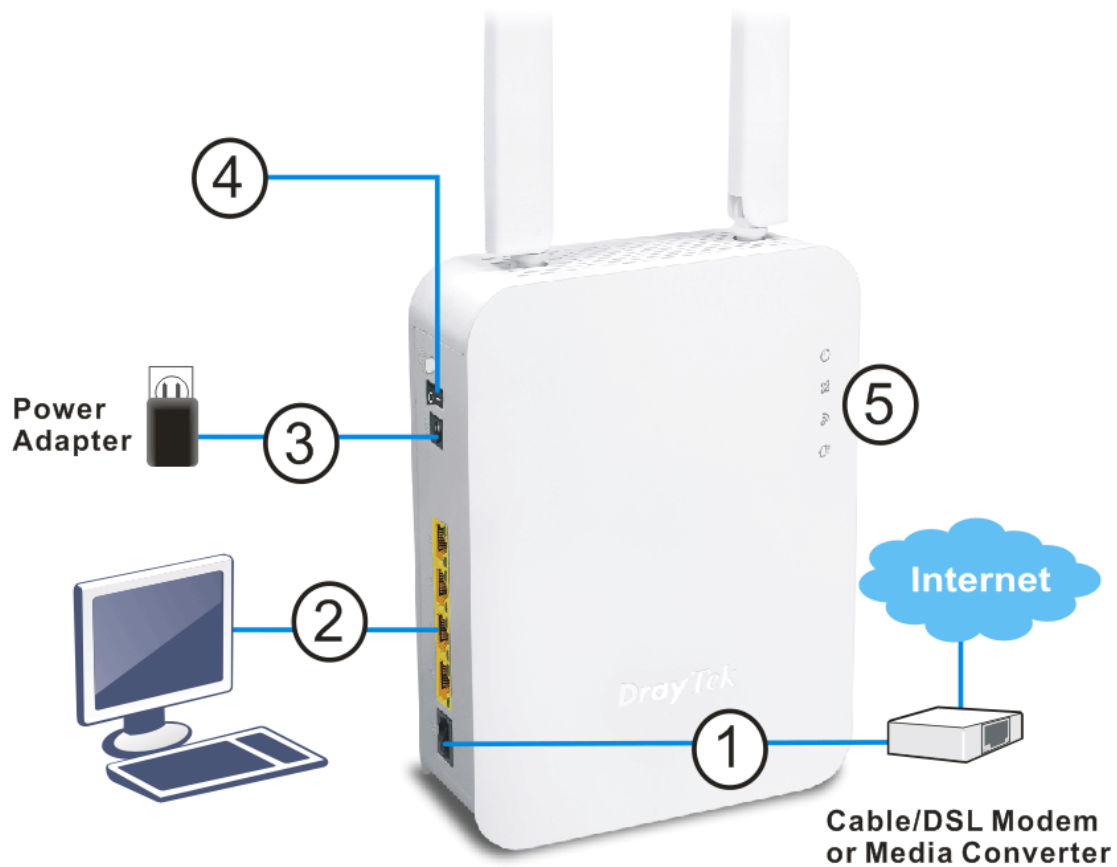



### 3.3 Wall-Mounted Installation for ac series

Vigor router has keyhole type mounting slots on the underside.

1. Drill two holes on the wall. The distance between the holes shall be 168mm.
2. Fit screws into the wall using the appropriate type of wall plug.
3. With the screws installed, the router can be slotted into place.

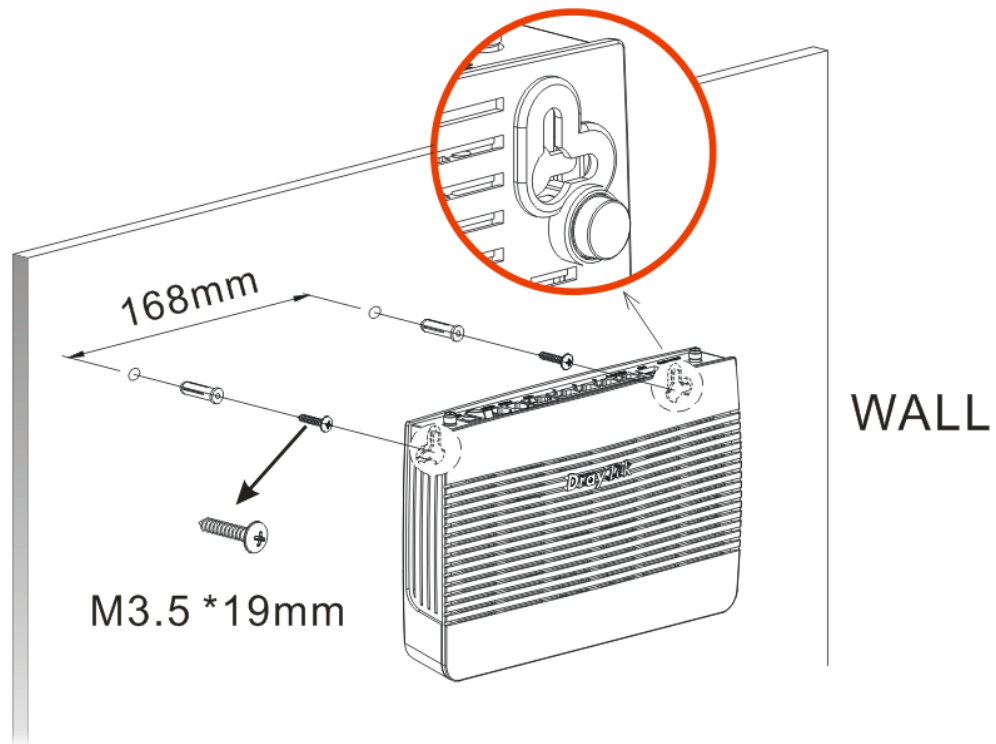

**Note**

The recommended drill diameter shall be 6.5mm (1/4").

4. When you finished about procedure, the router has been mounted on the wall firmly.

### 3.4 Wall-Mounted Installation for ax series

Vigor router has keyhole type mounting slots on the underside.

1. Drill two holes on the wall. The distance between the holes shall be 100.75mm. The recommended drill diameter shall be 6.5mm (1/4").
2. Fit screws into the wall using the appropriate type of screw plug.
3. Hang the Vigor router directly onto the screws.

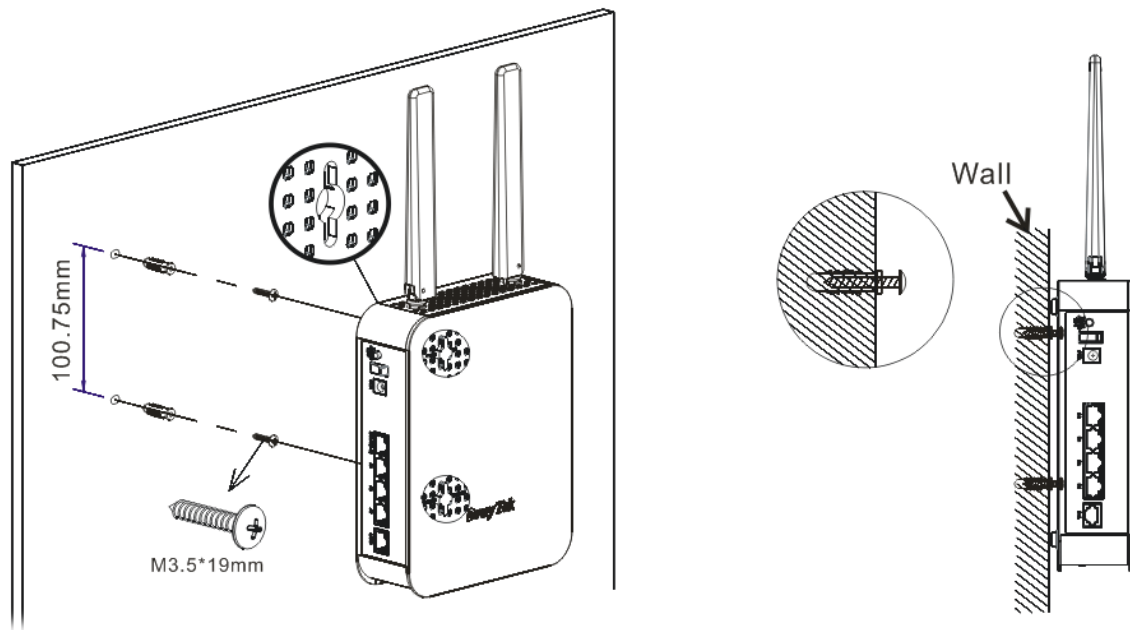

## 4. Software Configuration

To access Internet, please finish basic configuration after completing the hardware installation.

The **Quick Start Wizard** is designed for you to easily set up your router for Internet access. You can directly access the **Quick Start Wizard** via Web Configurator.

Make sure your PC connects to the router correctly.



### Note

You may either simply set up your computer to get IP dynamically from the router or set up the IP address of the computer to be the same subnet as the **default IP address of Vigor router 192.168.1.1**. For the detailed information, please refer to the section - Trouble Shooting in the User's Guide.

Open a web browser on your PC and type **http://192.168.1.1**. A pop-up window will open to ask for username and password. Please type "admin/admin" as the Username/Password and click **Login**. Here, we take Vigor2765 series as an example.

**DrayTek** **Vigor2765 Series**

**Login**

**Username**

**Password**

**Login**

**Security Warning: You are logging in without encryption which is not recommended. To login securely [click here](#).**

Copyright© 2000-2022 DrayTek Corp. All Rights Reserved.

Now, the Main Screen will pop up. Click Wizards>>Quick Start Wizard.

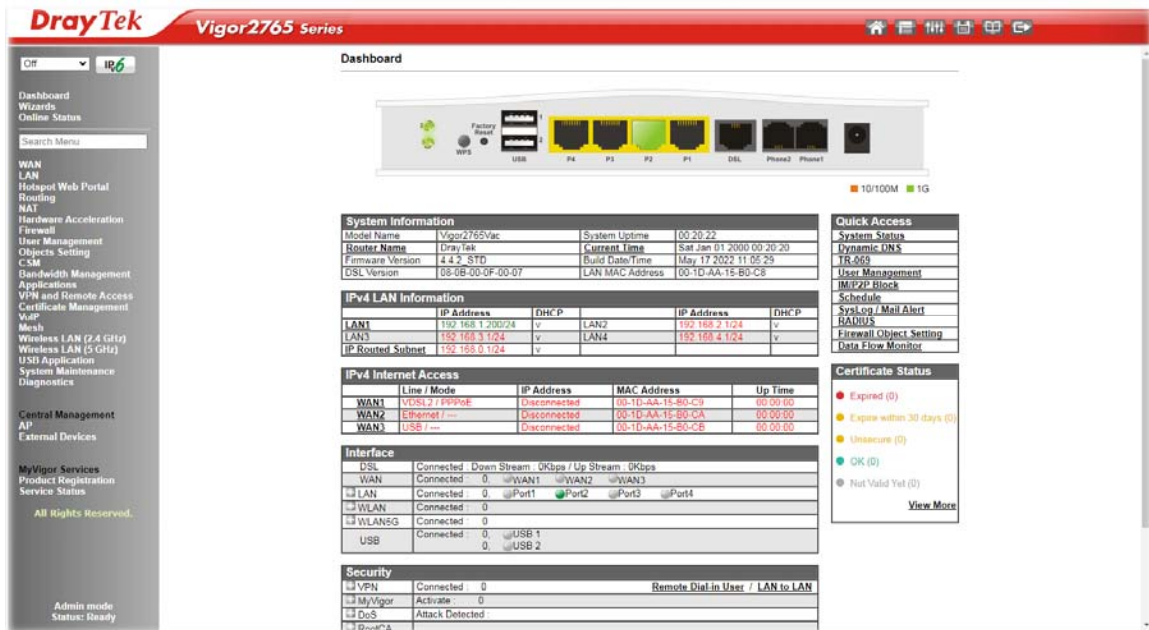

**Note**

The home page will change slightly in accordance with the router you have.

The first screen of Quick Start Wizard is entering login password. After typing the password, please click Next.

**Wizards >> Quick Start Wizard**

**Enter login password**

Please enter an alpha-numeric string as your **Password** (Max 83 characters)

Old Password:

New Password:

Confirm Password:

Password Strength: Weak **Medium** Strong

Strong password requirements:

1. Have at least one upper-case letter and one lower-case letter.
2. Including non-alphanumeric characters is a plus.

Hint: If you want to keep the password unchanged, leave the password blank and press "Next" button to skip this process.

< Back Next > Finish Cancel

On the next page as shown below, please select the WAN interface that you use. If DSL interface is used, please choose WAN1; if Ethernet interface is used, please choose WAN2; if 3G USB modem is used, please choose WAN3. Then click **Next** for next step. WAN1, WAN2 and WAN3 will bring up different configuration page. Here, we take **WAN1 (ADSL/VDSL2)** as an example.

Wizards >> Quick Start Wizard

**Select WAN Interface**

Select WAN Interface:	WAN1
Display Name:	
Physical Mode:	ADSL / VDSL2
DSL Mode:	Auto
Physical Type:	Auto negotiation
VLAN Tag insertion(ADSL):	Disable
Tag value	(0~4095)
Priority	(0~7)
VLAN Tag insertion (VDSL2) :	Enable
Tag value	(0~4095)
Priority	(0~7)

On the next page as shown below, please select the appropriate protocol according to the information from your ISP. For example, you should select PPPoE mode if the ISP provides you PPPoE interface. Then click **Next** for next step.

## PPPoE/PPPoA

1. Choose **WAN1** as WAN Interface and click the **Next** button; you will get the following page.

Quick Start Wizard

**Connect to Internet**

**WAN 1**

Protocol	PPPoE / PPPoA
<b>For ADSL Only:</b>	
Encapsulation	PPPoE LLC/SNAP
VPI	0 <input style="margin-left: 10px;" type="button" value=" Auto detect "/>
VCI	33
Fixed IP	<input type="radio"/> Yes <input checked="" type="radio"/> No(Dynamic IP)
IP Address	
Subnet Mask	
Default Gateway	
Primary DNS	8.8.8.8
Second DNS	8.8.4.4

2. After finished the above settings, simply click Next.

**Quick Start Wizard**

---

**Set PPPoE / PPPoA**

<b>WAN 1</b>	
Service Name (Optional)	<input type="text" value="2765"/>
Username	<input type="text" value="84005755@hinet.net"/>
Password	<input type="password" value="••••••••"/>
Confirm Password	<input type="password" value="••••••••"/>

3. Please manually enter the Username/Password provided by your ISP. Then click Next for viewing summary of such connection.

**Quick Start Wizard**

---

**Please confirm your settings:**

WAN Interface:	WAN1
Physical Mode:	ADSL / VDSL2
VPI:	1
VCI:	32
Protocol / Encapsulation:	PPPoE / LLC
Fixed IP:	No
Primary DNS:	8.8.8.8
Secondary DNS:	8.8.4.4

4. Click **Finish**. A page of **Quick Start Wizard Setup OK!!!** will appear. Then, the system status of this protocol will be shown.
5. Now, you can enjoy surfing on the Internet.

## MPoA / Static or Dynamic IP

1. Choose WAN1 as WAN Interface and click the Next button; you will get the following page.

Quick Start Wizard

---

Connect to Internet

**WAN 1**

Protocol: MPoA / Static or Dynamic IP ▼

**For ADSL Only:**

Encapsulation: 1483 Bridged IP LLC ▼

VPI: 0      Auto detect

VCI: 33

Fixed IP:  Yes     No(Dynamic IP)

IP Address:

Subnet Mask:

Default Gateway:

Primary DNS: 8.8.8.8

Second DNS: 8.8.4.4

< Back    Next >    Finish    Cancel

2. Please type in the IP address/mask/gateway information originally provided by your ISP. Then click Next for viewing summary of such connection.

Quick Start Wizard

---

**Please confirm your settings:**

WAN Interface: WAN1

Physical Mode: ADSL / VDSL2

VPI: 1

VCI: 32

Protocol / Encapsulation: 1483 Bridge LLC

Fixed IP: No

Primary DNS: 8.8.8.8

Secondary DNS: 8.8.4.4

< Back    Next >    Finish    Cancel

3. Click Finish. A page of Quick Start Wizard Setup OK!!! will appear. Then, the system status of this protocol will be shown.
4. Now, you can enjoy surfing on the Internet.

## 5. Customer Service

If the router cannot work correctly after trying many efforts, please contact your dealer/DrayTek for further help right away. For any questions, please feel free to send e-mail to "support@draytek.com".

### Be a Registered Owner

Web registration is preferred. You can register your Vigor router via <https://myvigor.draytek.com>.

### Firmware & Tools Updates

Due to the continuous evolution of DrayTek technology, all routers will be regularly upgraded. Please consult the DrayTek web site for more information on newest firmware, tools and documents.

<https://www.draytek.com>